

halfords

SINCE 1892

Sable R129 High Back Booster

Child height: 100-150cm

Approx: 3-12 years*

**2 YEAR
GUARANTEE**

User Instructions



Item Code: 819374, 819390

* Age shown is a guideline only

Contents

1. Product Introduction	01
1.1 Vehicle application	01
1.2 How to assemble car seat	02
1.3 Product overview	03
1.4 Vehicle 3-point seat belt	04
2. Car seat usage	04
2.1 Headrest adjustment	05
2.2 How to install car seat for a child's height from 100 to 150cm	05
2.3 How to install the booster cushion without the backrest for a child's height from 135 to 150cm	07
2.3.1 How to disassemble the car seat	07
2.3.2 Secure the booster cushion and child	08
3. Cleaning and maintenance	09
3.1 Removal and cleaning of the cover	09
3.1.1 How to remove the cover	09
3.1.2 To install the seat cover	10
3.1.3 Washcare instructions	10

SAFETY WARNINGS



Thank you for purchasing our child seat. Please ensure you fully read and follow the instructions provided. Please retain instructions for future use. If you have any further questions please contact your local store.

- Before using, please read the instruction manual carefully. The product is a safety product and is only safe when used in accordance with the instruction manual.
- This car seat is compliant with ECE R129/03.
- Do not use a child seat if the vehicle seat is equipped with an active front air bag. This can be dangerous. This does not apply to side airbags.
- It is most important that the seat belt is correctly routed.
- Never make unauthorised modifications or changes to the product.
- Never use the child car seat if it has been in an accident, or if it has become badly worn.
- Do not leave your children in the seat unattended at any time.
- In hot weather the plastic and metal parts of the product may become hot. You should cover the seat when not in use, especially when your car is parked in the sun.
- Ensure that all luggage and objects likely to cause injury in the event of an accident are properly secured.
- Never use the child car seat without the cover. Only covers approved by the manufacturer can be used.
- The child car seat must be secured when not in use.
- Store this child car seat in a safe place when it is not being used. Avoid placing heavy objects on it.
- Most accidents occur on short trips. So do not be tempted to avoid using the seat simply because you are not travelling very far.
- Keep the plastic bag away from your child as it could cause suffocation.
- Do not expose the child seat to any corrosive substances. Use a wet towel to clean the plastic body of the child seat.

- Make sure the child car seat belt is adjusted to a suitable position and ensure the belt is not twisted.
- Please ensure the lap belt is worn low down across the pelvis.
- Do not use this product second hand as you may never know its history.
- The rigid items and plastic parts of a child restraint must be located and installed so that they are not liable, during everyday use of the vehicle, to become trapped by a movable seat or in a door of the vehicle.
- Ensure that the seat is not damaged by heavy luggage, movable seats or slamming the car door etc.
- This product is only suitable if the vehicle is fitted with 3-point retractor safety belts, approved to UN/ECE Regulation NO.16 or other equivalent standards.

1. Product introduction

1.1 Vehicle application

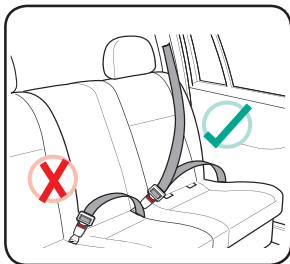



 Correct  Wrong

This car seat is suitable for conventional use in all cars equipped with 3 point seat belts that are fitted in accordance with European standard (ECE -16 or equivalent standard).

Important: The child seat must only be installed using a lap and diagonal seat belt.



 Suit 
Forward installation

- Warning:**  Do not use this child seat in a passenger seat equipped with active airbags.
-  Only suitable for use fitted with 3-point safety belts. Approved to ECE Regulation No.16 or other equivalent standards.

1.2 How to assemble car seat

 Please follow the steps below:

1. Combine the base with the backrest as shown in picture 1 below.

2. Raise the backrest. Make sure the hooks are secured (pictures 2 & 3).

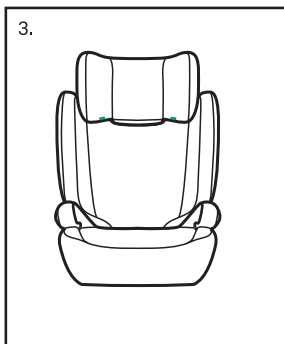
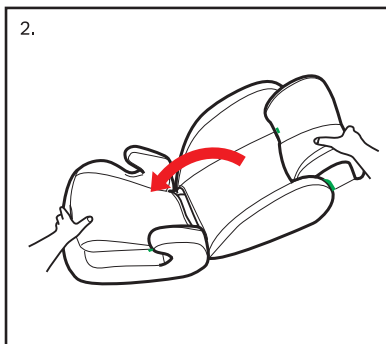
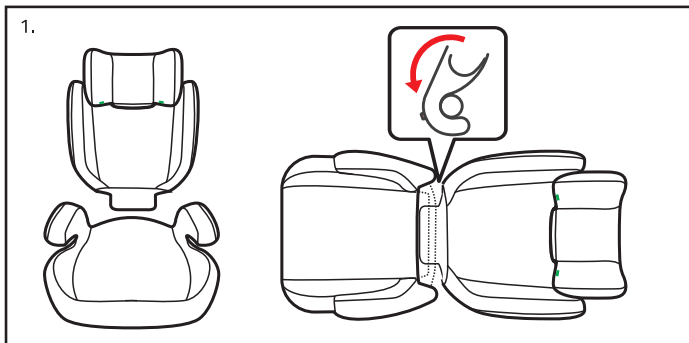

1.3 Product overview

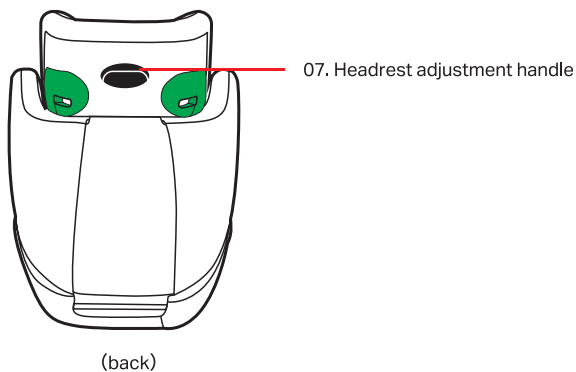
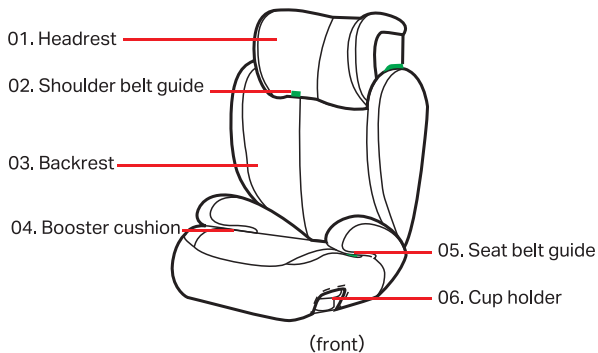

1.4 Vehicles 3 point seatbelt

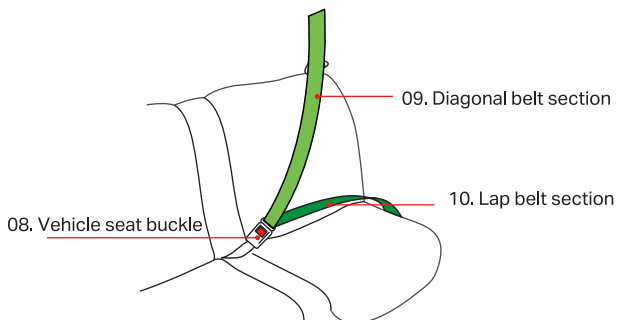

2. Car seat usage

This car seat is suitable for children with a height of between 100-150cm. The booster cushion without the backrest fitted should not be used until the child's height is greater than 135cm.

100-150cm



135-150cm



2.1 Headrest adjustment

⚠ Please follow the steps below:

To adjust the level of the headrest, pull the headrest adjustment handle and move the headrest up or down accordingly. As shown in picture 4.

⚠ WARNING:

Please make sure the child's head is positioned in the middle of the headrest. As shown in picture 5.

Please make sure the headrest is locked when using this car seat.

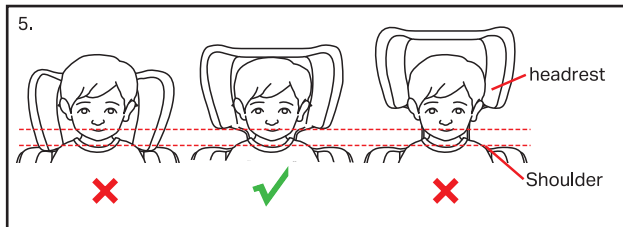
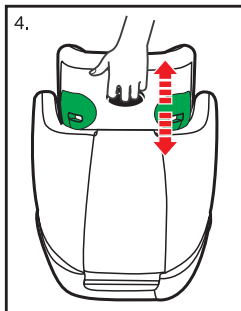

2.2 How to install the car seat for a child's height from 100 to 150cm

Place your child in the seat. Adjust the headrest by squeezing and pulling the headrest handle up into the required position. Take the adult seat belt, feed the diagonal belt through the shoulder belt guide. As shown in picture 6.

Pull the belt across the child as shown and then take both the diagonal and lap belts and pull under the armrest. Insert the belt end into the buckle until you hear an audible click as shown in picture 7.

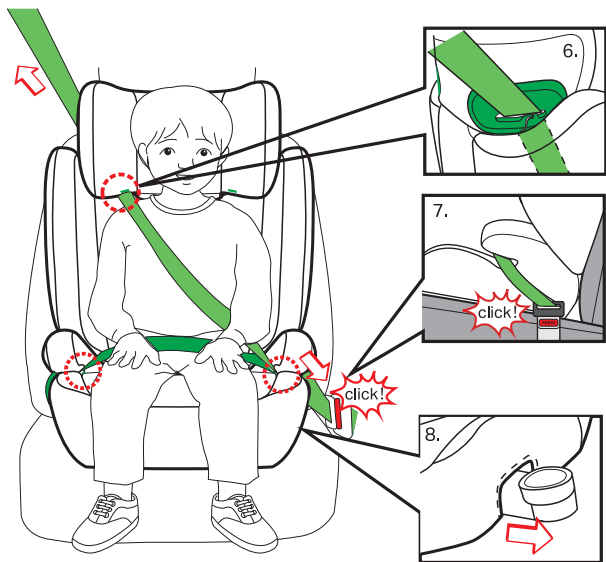

The cup holders on both sides of the base can be directly pulled out for use as shown by picture 8.

Please make sure the car seat belt is not twisted as shown by picture 9.

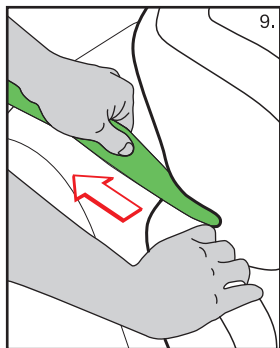

2.3. How to install the booster cushion without the backrest for a child's height from 135 to 150cm

WARNING:

The booster cushion without the backrest fitted should not be used until your child's height is greater than 135cm.



2.3.1 How to disassemble the car seat

Please follow the steps below:

1. By pushing the backrest down, lower it into a flat position as shown by picture 10 below.

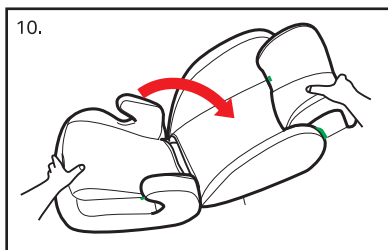

2. Pull the base and the backrest apart.

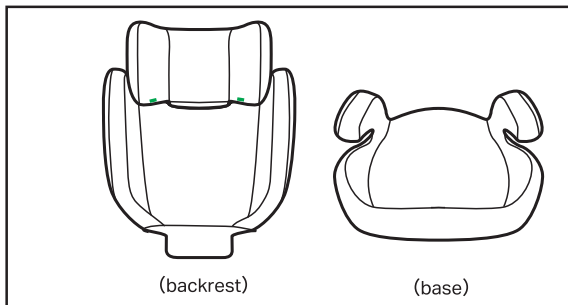

2.3.2 Secure the booster cushion and child

Place your child in the booster cushion. Pull the belt across the child as shown. Pull the diagonal belt over the top of the armrest and pull the lap belt under the armrest. It is important that the seatbelt crosses the middle of the shoulder and is tight across the lap. Ensure that the lap section is worn low down and firmly engaged with the pelvis. The diagonal belt must pass over the child's shoulder and NOT across the neck. Insert the belt end into the buckle until you hear an audible click as shown in picture 11. Please make sure the car seat belt is not twisted as shown in picture 12. Remove the excess slack from both the lap and diagonal belts by pulling them tight.

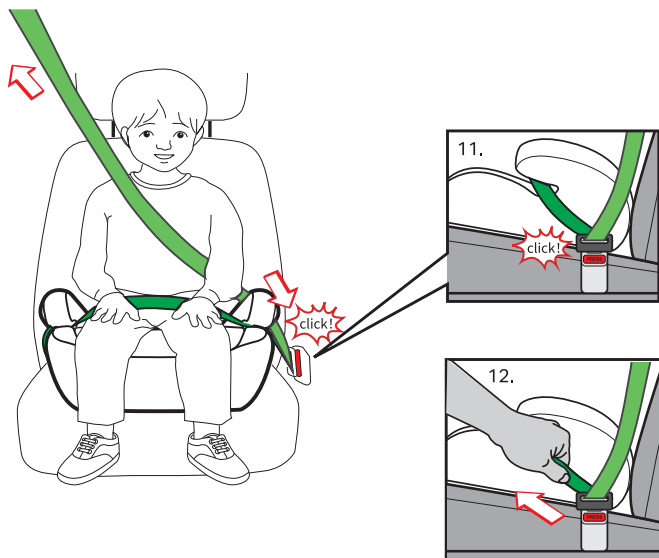

3. Cleaning and maintenance

3.1 Removal and cleaning of the cover

3.1.1 How to remove the cover

 **Please follow the steps below:**

Please disassemble the backrest and booster (See note: 2.3.1).

1. Unfasten the snap fasteners at the bottom of the backrest and pull off the cover as shown in picture 13.
2. Pull out the flap at the bottom of the backrest and pull the cover over and off the headrest as shown in picture 14.

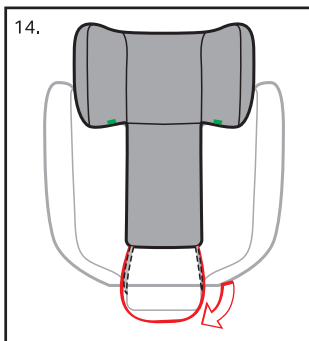
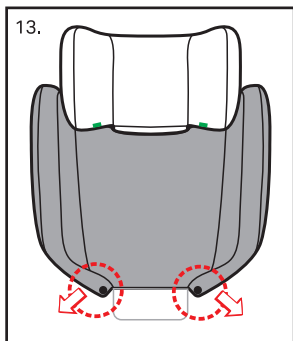

3. To remove the cover from the booster cushion, starting at the rear of the seat, grip the fabric cover and pull it off the seat. As shown in picture 15.

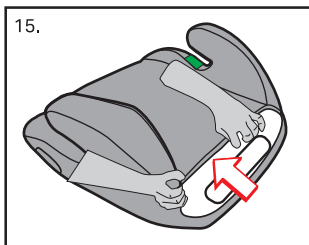

3.1.2 To install the seat cover

To reattach the cover, follow the reverse instructions for removing the cover.

3.1.3 Washcare instructions

The cover and plastic parts of the child seat can be cleaned with a wet cloth using a mild detergent and warm water. Ensure no soap gets into the buckle or adjusters. Do not use chemical cleaners or bleach on any part of the car seat. Dry thoroughly before use.



WARNING



This is an i-Size car seat enhanced child restraint system. It is approved according to UN Regulation No.129/03, for use primarily in "i-Size seating positions" as indicated by vehicle manufacturers in the vehicle user's manual. If in doubt, consult either the enhanced child restraint system manufacturer or the retailer.

OUR QUALITY GUARANTEE

This item is covered by our two-year Quality Guarantee. In the unlikely event that it develops a fault within this period, we will replace it. For more details and full conditions, see halfords.com/guarantees or ask in-store.

CONTACT US

UK: Halfords Ltd, B98 0DE
www.halfords.com

ROI: Halfords c/o DWF, Dublin 1
www.halfords.ie

Item Code: 819374, 819390